

Features:

- 5W power rating in a small chip size 2818 size
- Excellent long-term stability
- 100% RoHS compliant and lead free without exemption
- Halogen free
- AEC-Q200 compliant
- REACH compliant



Applications:

- Power modules
- Frequency converters
- Inverter control
- Power management
- Current sensor for power hybrid sources

Electrical Specifications			
Type/Code	Power Rating (W)	TCR (ppm/°C)	Ohmic Range (Ω) and Tolerance 1% and 5%
HCSM2818	5	± 100	0.002
		± 200	0.003, 0.004, 0.005 (*)
		± 75	0.01, 0.015, 0.02, 0.025 (*)

(*) Other values may be available, but may require higher MOQ. Contact Stackpole.

Mechanical Specifications

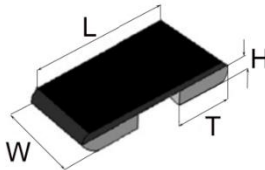

Type/Code	L	W	H	T	Unit
HCSM2818	0.281 ± 0.010	0.195 ± 0.010	0.065 ± 0.010	0.114 ± 0.010	inches
	7.15 ± 0.25	4.95 ± 0.25	1.65 ± 0.25	2.90 ± 0.25	mm

Power Derating Curve:

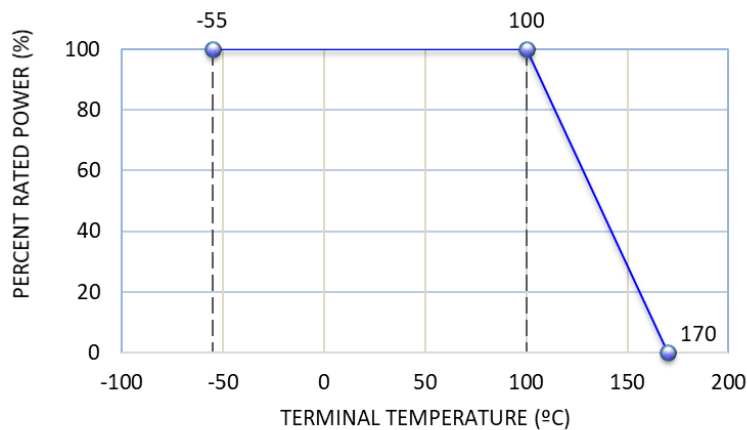

Operating temperature range of -55°C to 170°C.
Storage condition: 5°C ~ 35°C, humidity of 40% ~ 75%.

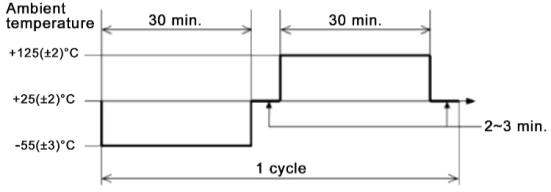
Environmental Performance Characteristics			
Test	Test Method	Test Specification	Test Condition
Short Time Overload	JIS-C5202-5.5	$\Delta R: \pm (1\% + 0.0005 \Omega)$	4 times rated power for 5 seconds
Temperature Coefficient of Resistance (TCR)	JIS-5202-5.2	Refer to Electrical Specifications	+25°C / +125°C $TCR (ppm/^\circ C) = \frac{\Delta R}{R \times \Delta t} \times 10^6$
Damp Heat with Load	MIL-STD-202 Method 103	$\Delta R: \pm (1\% + 0.0005 \Omega)$	The specimens shall be placed in a chamber and subjected to a relative humidity of 90 ~ 95% and a temperature of 40°C ± 2°C for a period of 1000 hours with applied rated power, 1.5 hours ON and 0.5 hour OFF.
High Temperature Exposure	JIS-C5202-7.2	$\Delta R: \pm (1\% + 0.0005 \Omega)$	The chip (mounted on board) is exposed in the heat chamber, 125°C ± 3°C for 1000 hours
Load Life	JIS-C5202-7.10	$\Delta R: \pm (1\% + 0.0005 \Omega)$	Apply rated power at 70°C ± 2°C for 1000 hours with 1.5 hours ON and 0.5 hour OFF.
Rapid Change of Temperature	JIS-C5202-7.4	$\Delta R: \pm (1\% + 0.0005 \Omega)$	The chip (mounted on board) is exposed, -55°C ± 3°C (30 minutes) / +125 ± 2°C (30 minutes) for 5 cycles. The following conditions as the figure below. 

Operating temperature range is -55°C to +170°C

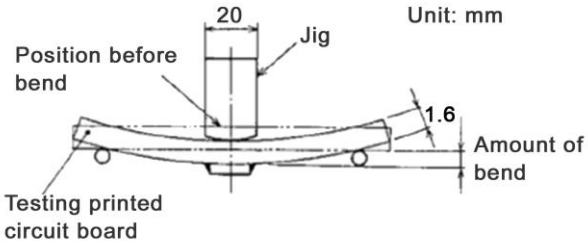
Function Performance Characteristics			
Test	Test Method	Test Specification	Test Condition
Bending Strength	JIS-C5202-6.1	$\Delta R: \pm (1\% + 0.0005 \Omega)$	Mount the chip to test substrate. Apply pressure in direction of arrow unit band width reaches 2 mm (+0.2 / -0 mm) illustrated in the picture below and hold for 10 ± 1 seconds. (JIS-C5202-6.1) 
Solvent Resistance	MIL-STD-202, Method 215	Verify marking permanency. (Not required for laser etched parts or parts with no marking).	The chip is completely immersed in isopropyl alcohol for 3 (+5/-0) minutes at 25°C ± 5°C.
Resistance to Solder Heat	MIL-STD-202, Method 210	$\Delta R: \pm (1\% + 0.0005 \Omega)$	The chip shall be immersed into the flux specified in the solder bath 260°C ± 5°C for 10 ± 1 seconds.

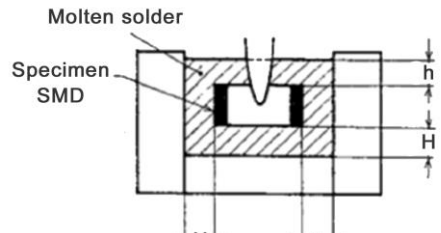
Function Performance Characteristics (cont.)			
Test	Test Method	Test Specification	Test Condition
Solderability	JIS-C5202-6.11	Solder shall cover 95% or more of the electrode area	<p>The chip shall be immersed into the flux specified in the solder bath $235^{\circ}\text{C} \pm 5^{\circ}\text{C}$ for 2 ± 0.5 seconds. It shall be immersed to a point 10mm from its root. (Sn96.5/Ag3.0/Cu0.5)</p>  <p>h = 10 mm H = 10 mm min.</p>

Note: 5W with total solder pad trace size of 500 mm^2 . The surface temperature of component should be below 100°C .

Taping Specifications – Embossed Plastic Tape

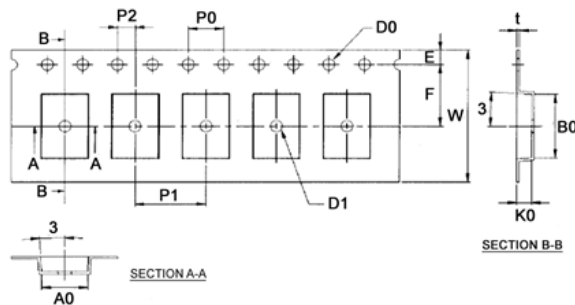

Type/Code	A	B	E	F	W	t	Unit
HCSM2818	0.205 ± 0.004 5.21 ± 0.10	0.303 ± 0.004 7.69 ± 0.10	0.069 ± 0.004 1.75 ± 0.10	0.295 ± 0.004 7.50 ± 0.10	0.630 ± 0.012 16.00 ± 0.30	0.012 ± 0.002 0.30 ± 0.05	inches mm
	P0	P1	P2	D0	D1	Unit	
	0.157 ± 0.004 4.00 ± 0.10	0.315 ± 0.004 8.00 ± 0.10	0.079 ± 0.004 2.00 ± 0.10	0.059 ± 0.004 1.50 ± 0.10	0.059 ± 0.004 1.50 ± 0.10	inches mm	

Recommended Pad Layouts

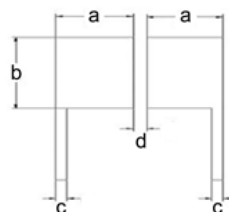

Type/Code	a	b	c	d	Unit
HCSM2818	0.138 3.50	0.209 5.30	0.020 0.50	0.024 0.60	inches mm

Soldering Recommendations:

- Peak reflow temperatures and durations
 - ✓ IR Reflow Peak = 260°C max for 10 seconds
 - ✓ Wave Solder = 260°C max for 10 seconds
- Compatible with lead and lead-free solder reflow processes
- Recommended IR reflow profile:

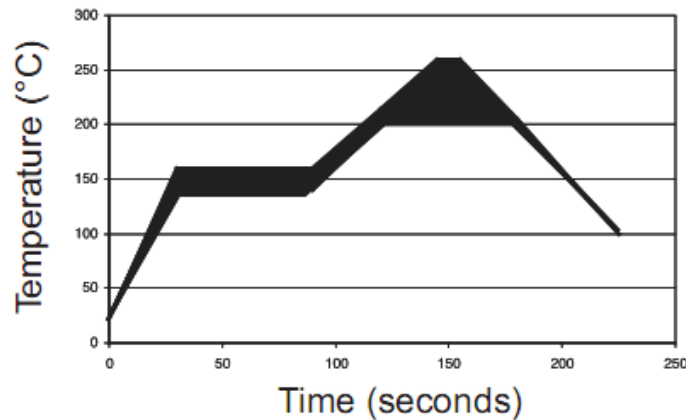

RoHS Compliance

Stackpole Electronics has joined the worldwide effort to reduce the amount of lead in electronic components and to meet the various regulatory requirements now prevalent, such as the European Union’s directive regarding “Restrictions on Hazardous Substances” (RoHS 3). As part of this ongoing program, we periodically update this document with the status regarding the availability of our compliant components. All our standard part numbers are compliant to EU Directive 2011/65/EU of the European Parliament as amended by Directive (EU) 2015/863/EU as regards the list of restricted substances.

RoHS Compliance Status						
Standard Product Series	Description	Package / Termination Type	Standard Series RoHS Compliant	Lead-Free Termination Composition	Lead-Free Mfg. Effective Date (Std Product Series)	Lead-Free Effective Date Code (YY/WW)
HCSM	High Current Shunt Resistor	SMD	YES	100% Copper	Always	Always

“Conflict Metals” Commitment

We at Stackpole Electronics, Inc. are joined with our industry in opposing the use of metals mined in the “conflict region” of the eastern Democratic Republic of the Congo (DRC) in our products. Recognizing that the supply chain for metals used in the electronics industry is very complex, we work closely with our own suppliers to verify to the extent possible that the materials and products we supply do not contain metals sourced from this conflict region. As such, we are in compliance with the requirements of Dodd-Frank Act regarding Conflict Minerals.

Compliance to “REACH”

We certify that all passive components supplied by Stackpole Electronics, Inc. are SVHC (Substances of Very High Concern) free and compliant with the requirements of EU Directive 1907/2006/EC, “The Registration, Evaluation, Authorization and Restriction of Chemicals”, otherwise referred to as REACH. Contact us for complete list of REACH Substance Candidate List.

Environmental Policy

It is the policy of Stackpole Electronics, Inc. (SEI) to protect the environment in all localities in which we operate. We continually strive to improve our effect on the environment. We observe all applicable laws and regulations regarding the protection of our environment and all requests related to the environment to which we have agreed. We are committed to the prevention of all forms of pollution.

How to Order

